



Advers

Autoterm Test

User Manual

Contents

Introduction	
Overview	3
Main functions	3
System requirements	3
Getting started	
Connection to control unit	3
Product selection	5
Reading product malfunctions	5
Changing the control unit settings	6
Diagnostics performance	6
User interface	
Connection tab	7
View tab	8
Diagnostics tab	8
Control tab	9
Malfunctions tab	10
Diagram window	11
Table window	12
Settings window	12
Information window	13
Report window	14
Fuel pump flow rate check	
Design and purpose	16
Connection diagram	17
Measurement procedure	18
Troubleshooting	20
Connection to the air heater	22

Introduction

Overview

The Autoterm Test software is designed for diagnostics of Planar, Binar and 14TC air heaters.

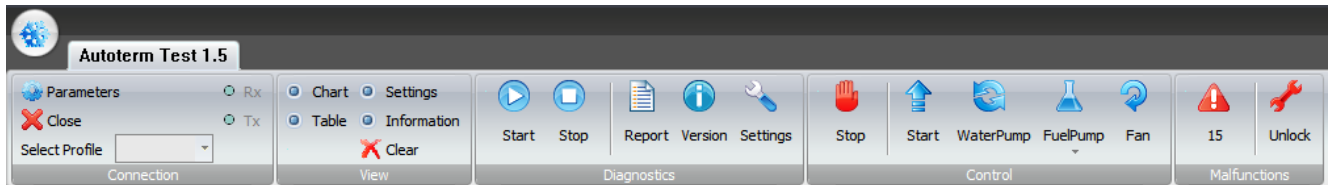

Main functions

- display of operation parameters in table and diagram forms
- control unit setup
- product report display
- air heater units control
- saving of data obtained for further processing

System requirements

32- or 64-bit PC with OS Microsoft Windows XP, Vista, 7, 8, 10.

Getting started

Connection to control unit

Drivers for the USB adapter must be downloaded and installed prior the initial connection.

Drivers are on the website:

<http://www.ftdichip.com/Drivers/VCP.htm>

Download of drivers in the form of an .exe file is recommended.

For example, see the website:

http://www.ftdichip.com/Drivers/CDM/CDM20814_Setup.exe

To install drivers, run the downloaded file.

Then, connect the adapter to the USB port of the computer; drivers will be detected automatically and the adapter will be installed.

A computer USB connector and USB adapter are required to connect the software to the control unit. This adapter must be connected between the computer USB port and the connector for the air heater panel.

Upon software startup, the system determines the connected port automatically. Thus, if only one port is available, no additional settings are required. Otherwise, the required port must be selected in the connection parameters.

When the product is selected within the profiles, the port will be opened automatically; no additional action is required.

If required, the port can be closed by pressing the  icon in the Connection section. Double-clicking on the icon will restore the connection.

If an attempt is made to connect to a non-existent port or in the event of adapter disconnection, a message will appear.

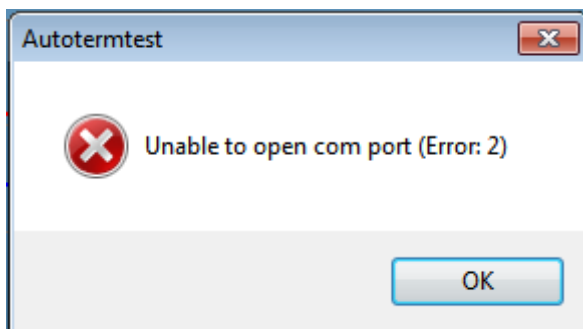

Product selection

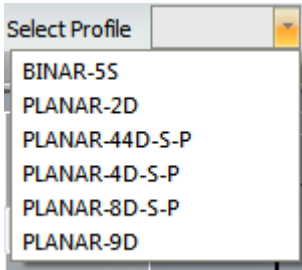

After adapter connection to the product, select the required air heater from the list of profiles. In case of incorrect selection, a message will be displayed in the window.

Reading product malfunctions



To read the current malfunction of the control unit, click the  icon in the Malfunctions section. The malfunction code will be displayed. For additional information, place the cursor on the Malfunctions section.

When the diagnostic process is started, the malfunctions display will be updated automatically; no additional action is required.



To read previous malfunctions of the air heater, click the  icon in the Diagnostics section. In the report window, the Malfunctions section contains a table with a list of recent malfunctions (the number of possible records depends on the control unit software type and version).



Changing the control unit settings





To read the control unit settings, click the  icon in the Diagnostics section. The list of editable settings will appear in the Settings window. To save the settings in the control unit, click the **Apply** button in the Settings window. Note that saving settings on some control units is only possible with the air heater shut off.

Diagnostics performance





Start the heater using the  button in the Control section, then click the  button in the Diagnostics section. The data on pre-heater parameters will start to be gathered in the Table window. To display the required parameters, double-click the corresponding column - in the Diagram window list, the parameter designation will be added, highlighted with the diagram curve color. To cancel parameters selection, double-click the respective column in the Table window.

In case a malfunction occurs during diagnostics operation, the code of this malfunction will be displayed in the Malfunctions section. When the cursor is placed on the code, the screen prompt with a malfunction designation will appear.

To finish the diagnostics, click the  button in the Diagnostics section. To finish the air heater operation, press the  button in the Control section.

Collected data may be saved to file for sending or further processing, by clicking the  icon in the upper left corner. Then press **Save** and select the location and name of the file to be saved.

To upload data from the saved file, click the  icon in the upper left corner. Then press **Open** and select the required file.

Pre-heater data obtained can also be deleted by pressing the  icon in the View section.

If required, the parameters display may also be paused by pressing the  icon in the Connection section. To resume, press the  icon.

User interface

Connection tab



 **Parameters** Displays the window with port connection settings; select the required port from the drop-down list.

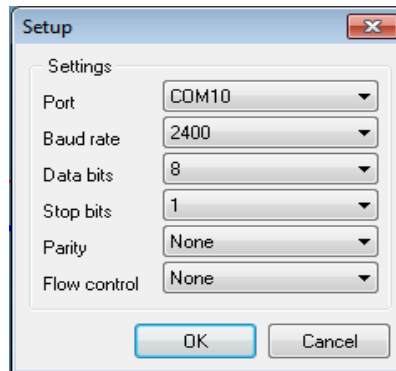

 **Open** Opens connection to the port; if in the port is not available, a window with a warning will appear.

 **Close** Closes connection to the port; may be required for control unit disconnection with the software running.

Select profile Displays the list of control unit profiles; click the desired profile to select. After selection, the port will be opened automatically; no additional action is required.

 **Rx** Indicator of air heater data reading in progress.

 **Tx** Indicator of data transmission to the air heater in progress.

View tab





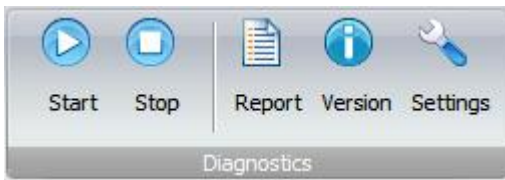

The **Diagram**, **Table**, **Settings** and **Data** buttons are used to open and close the respective windows.

 **Clear** Clears the air heater data collected and the information window.

Diagnostics tab



-  **Start** Starts the process of air heater data collection; the process can be monitored with the **Rx** icon display. In this case, the air heater operation remains unchanged; to start the air heater, press the **Start** icon in the Control section.
-  **Stop** Stops air heater data collection. In this case, the air heater operation remains unchanged; to stop the air heater, press the **Stop** icon in the Control section.
-  **Report** Displays a new window with the air heater report; the display is only possible with the diagnostics stopped. Contains data on the pre-heater serial number, number of successful and unsuccessful starts, time of operation in various modes and also the list of recent malfunctions with associated parameters.
-  **Version** Displays in the Information window the software version of the air heater control unit.
-  **Settings** Reads settings from the air heater control unit with display to the Settings window.

Control tab



 **Stop**

Shuts down the air heater, pump, fuel pump or air blower.

 **Start**

Starts the air heater. In case of locked air heater, use the **unlock** button in the Malfunctions section.

 **Pump**

Starts the air heater pump. Applicable for hydronic pre-heaters; this icon is not available in air heaters profiles.

 **Fuel pump**

Starts the fuel pump. The drop-down list enables selection of the fuel pump type for the flow rate check. After start, the pump must pump 5 ml of fuel.

 **Air blower**

Switches the air blower to maximum speed.

Malfunctions tab



 **Malfunction**

In case of malfunctions, it displays the malfunction code; place the cursor to display the screen prompt with description. To read the malfunction code from the control unit, click the **Error** icon. With the diagnostic process started, the update is performed automatically; no additional action is required.



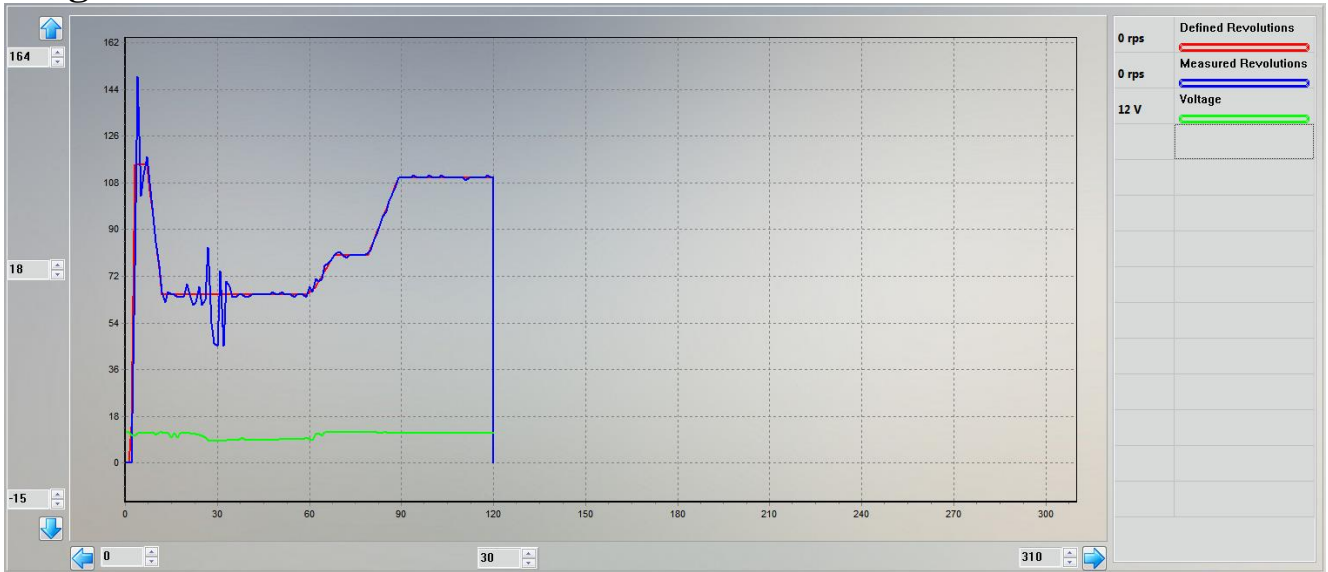

 **Unlock**

Unlocks an air heater that was locked due to several failed ignition attempts in a row.

Diagram window



Enables assessment of the change in air heater operation parameters.

To change the scale of the display, use     buttons or input panels located nearby. After the panels are clicked, the values may be changed by scrolling the mouse wheel. The middle panels are used to change the grid step.

The selected parameters are located in the list on the right. The underlining color corresponds to the color of the diagram curve. To change the color, double click the desired parameter; the color selection window will appear. The selected colors are saved automatically when the program is closed.

A single click on the parameter will automatically adjust the diagram window height; other curves will not be displayed. To display remaining parameters, click any blank field in the list.

To clear the displayed data, click the  icon in the View section.

Use the Table window to select or cancel display of the desired parameters.

Table window

Mode of opera	Stage/Mode	Running time	Defined Revol	Measured Rev	Glow Plug	Fuel pump freq	Flame temper	Liquid temper	Overheat temp	Board temper	Voltage	Fault code	Engine state	Relay stat
waiting for a cc	0,1	120	0	0	0	0	30	29	30	30	12	15	0	0
waiting for a cc	0,1	120	0	0	0	0	30	29	30	30	12	15	0	0
waiting for a cc	0,1	120	0	0	0	0	30	29	30	30	12	15	0	0
waiting for a cc	0,1	120	0	0	0	0	30	29	30	30	12	15	0	0
waiting for a cc	0,1	120	0	0	0	0	30	29	30	30	12	15	0	0

Contains a table with a list of air heater parameters. Enables selection of desired parameters for display in the Diagram window. To select or cancel the displayed parameter, double-click the corresponding column. When the cursor is placed on the parameter name or value, the screen prompt will appear.

To clear the table data, click the  icon in the View section.

Settings window

Preheater. Wait mode temperature:
88

Worming up:
auto

Warm up. Wait mode temperature:
80

Relay:
auto

Relay on temperature:
50

Water pump signal:
constant

Water pump if engine started:
off

Pump in standby mode:
on

Signalling channel:
on

Preheater. Wait mode temperature:
88

Enables display or change of air heater settings. To view the control unit settings, click the  icon in the Diagnostics section. After editing, the settings can be saved to the control unit by clicking the **Apply** button.

Attention! Not all control units allow saving of settings with the air heater in operation.

Information window

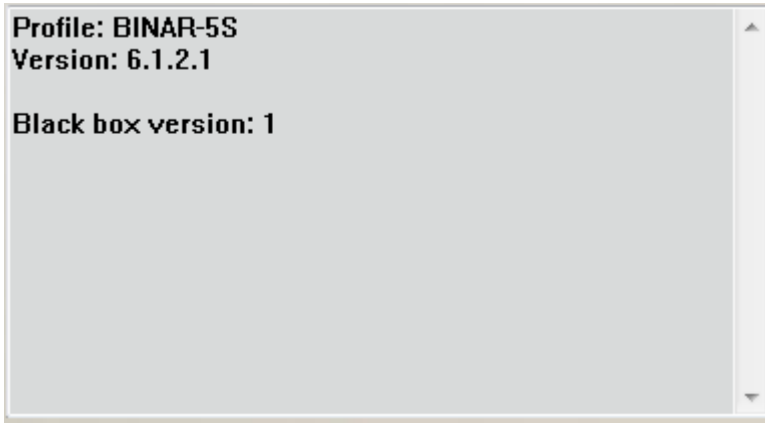

This window displays information on the selected profile, control unit software version and the black-box version.

Report window

01.03.2018 11:41
Operation report Binar-5S
code: 3031
series: 131429

Number of starts
in all: 915
without faults: 488
with faults: 399
first attempt: 21
second attempt: 7
water pump only mode: 48
warming up mode: 56

no ignition: 83
break power supply: 28

Running time
total work time: 26h, 57m.
high mode: 1h, 39m.
middle mode: 1h, 39m.
low mode: 1h, 2m.
wait mode: 2h, 22m.
water pump only mode: 2h, 2m.

Faults
the column of the last fault: 7

	1	2	3	4	5	6	7	8	9	10
fault code	24	13	30	14	13	14	15	13	30	13
repetition number	1	2	1	1	2	1	1	1	2	1
stage	2	2	2	2	2	2	2	2	2	2
mode	4	4	4	1	4	3	3	4	3	4
total work time	202	245	235	19	245	47	59	245	76	245
mode work time, sec	48	91	81	17	91	14	26	91	43	91
voltage, V	5,8	10	9,9	12	9,9	9,2	9,2	9,9	10	9,6
flame temperature	402	315	314	304	319	299	300	311	299	310
liquid temperature	133	34	33	31	39	27	28	31	26	30
overheat temperature	133	36	34	32	39	27	28	33	27	31
board temperature	127	39	38	29	43	27	28	36	28	36
second attempt of ignition	0	0	0	0	0	0	0	0	0	0
flame breaks number	0	0	0	0	0	0	0	0	0	0

The report contains data on the pre-heater serial number, number of successful and unsuccessful starts, operating time in various modes, and also the list of recent malfunctions with associated parameters.

Additional data can be added to the report by using special data fields.



01.03.2018 11:41

Operation report Binar-5S

code: 3031

series: 131429

Number of starts

in all: 915
 without faults: 488
 with faults: 399
 first attempt: 21
 second attempt: 7
 water pump only mode: 48
 warming up mode: 56

no ignition: 83
 break power supply: 28

Running time

total work time: 26h. 57m.
 high mode: 1h. 39m.
 middle mode: 1h. 39m.
 low mode: 1h. 2m.
 wait mode: 2h. 22m.
 water pump only mode: 2h. 2m.

Faults

the column of the last fault: 7

	1	2	3	4	5	6	7	8	9	10
fault code	24	13	30	14	13	14	15	13	30	13
repetition number	1	2	1	1	2	1	1	1	2	1
stage	2	2	2	2	2	2	2	2	2	2
mode	4	4	4	1	4	3	3	4	3	4
total work time	202	245	235	19	245	47	59	245	76	245
mode work time, sec	48	91	81	17	91	14	26	91	43	91
voltage, V	5,8	10	9,9	12	9,9	9,2	9,2	9,9	10	9,6
flame temperature	402	315	314	304	319	299	300	311	299	310
liquid temperature	133	34	33	31	39	27	28	31	26	30
overheat temperature	133	36	34	32	39	27	28	33	27	31
board temperature	127	39	38	29	43	27	28	36	28	36
second attempt of ignition	0	0	0	0	0	0	0	0	0	0
flame breaks number	0	0	0	0	0	0	0	0	0	0



For report display, click the icon in the Diagnostics section; report

display is only possible with diagnostic operation stopped.

To print the report, click the  button.

Saving the report to file is also possible. Click the  icon and select the location and name of the file to be saved.

Fuel pump flow rate check.

Design and purpose

For this work, the fuel priming device (UPT-4) is required.

Fuel priming device is used to:

- fill fuel lines of hydronic pre-heaters and air heaters after installation or repair works;
- check fuel pump flow rate.

Attention! UPT must be operated by skilled personnel. Non-compliance to this requirement may lead to product damage and fire hazardous situations.

Technical Characteristics

Power supply voltage	12V / 24V
Priming frequency	5 Hz
Pulse duration	27 ms / 45 ms
Operation mode	1000 pulses / continuously
Operating temperature range	-30°C to +50°C

Connection diagram

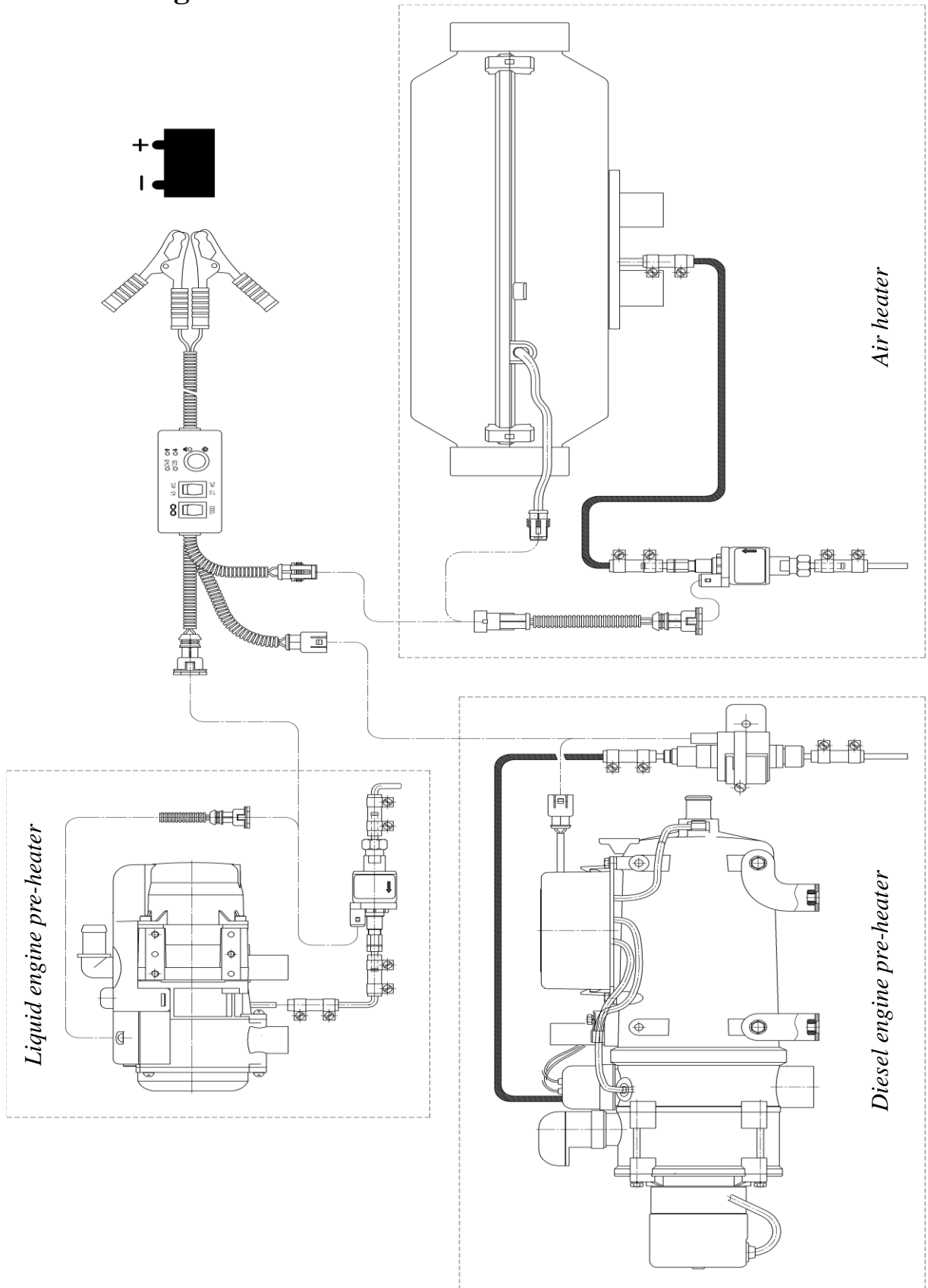

Fig.1

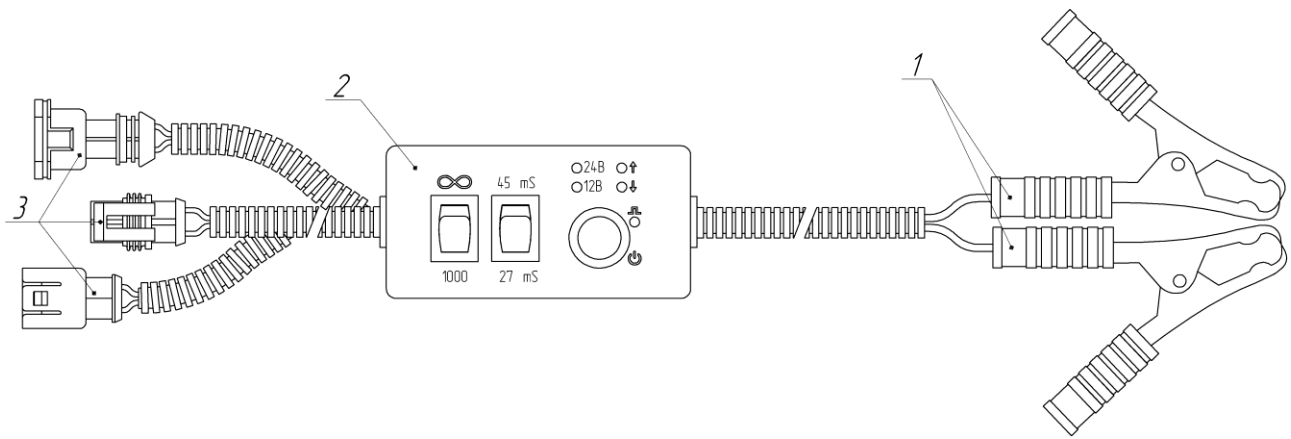

Fig.2

UPT components

The fuel priming device includes (Fig. 2):

1. Clips ("crocodile" type) for battery connection (red mark on the handle: "+", black mark: "-").
2. FUEL PRIMING DEVICE (UPT).
3. Fuel pump connection terminal blocks (direct connection or through adapter harness).

Measurement procedure

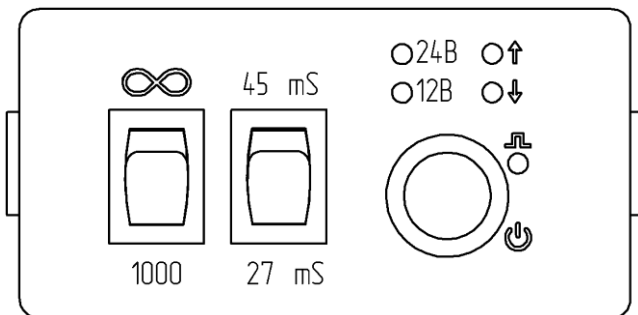

Fig.3

Connect the clips (Fig. 1, p. 2) to power supply or battery, connect the terminal block (Fig. 2, p. 3) to the fuel pump harness or directly to the fuel pump.

Once the clips are connected to the power supply, the "12 V" or "24 V" LED (based on supplied voltage) will light up on the UPT.

The "12 V" LED means that the voltage is above or equal to 12-13 V and less than or equal to 18 V.

The "24 V" LED means that the voltage is above 18 V and less than or equal to 24-26 V.

LEDs next to "↑" or "↓" mean that the supplied voltage is higher or lower than the specified range. (Important for fuel pump flow rate measurement.)

Based on the fuel pump used, pulse duration should be set to 27 or 45 ms.

For 4 or 4.4 ml pumps: 27 ms.

For 6.8 ml pumps: 45 ms.

Set operating mode:

- ∞ - for filling the fuel system, with visual filling control;
- 1000 - for fuel pump flow rate measurement.

Press the UPT start button "  ":

- If ∞, mode is selected, the device will operate until the button is pressed.
- If "1000" mode is selected, the device will only feed 1000 pulses per fuel pump.

To measure the fuel pump flow rate, disconnect the fuel line from the fuel pipe of the heating element and dip the pipe in the measuring flask. Set the "1000" operation mode and measure the current flow rate. Compare the current flow rate with the one specified on the fuel pump label (which is per 100 pulses).

During operation, the "  " LED blinks for each pulse, at a frequency of 5 Hz.

Attention! While the fuel system is filled, measures should be taken to prevent large amount of fuel from getting into the combustion chamber.

During the fuel pump flow rate measurement, prevent fuel from spilling on harnesses and other product components.

Troubleshooting

Heat exchanger overheating

Check the heating element inlet and outlet pipes for free inflow and outflow of heated air.

Test the overheating sensor on the heat exchanger; replace if necessary.

Possible overheating based on the temperature sensor readings

The temperature of the control unit sensor exceeds 55 degrees.

During 5-minute pre-start purging, the control unit is cooled insufficiently, or the control unit overheated during operation. Check the heating element inlet and outlet pipes for free inflow and outflow of air and repeat the startup for heater cooling.

Control unit integrated temperature sensor malfunction.

Replace the control unit

Flame detector malfunction.

Check the flame detector circuit for integrity with the sensor disconnected from the board. Resistance between leads must not exceed 10 Ω . A faulty flame detector must be replaced.

Flameout during heater operation.

Check the amount and flow of fuel supplied. Check the combustion air supply system and the gas exhaust pipe. If the air heater starts, check the fuel pump and replace if necessary.

Glow plug malfunction.

Test glow plug. Replace if necessary.

Fan motor malfunction.

Check the fan motor wiring for electrical conductance. Replace the motor if necessary.

Shutdown due to overvoltage.

Test the battery, the voltage regulator and power supply wiring.

All attempts to start failed.

In case all start attempts were used, check the plug, quantity and supply of fuel. Check the combustion air supply system and the gas exhaust pipe.

Shutdown due to undervoltage

Test the battery, the voltage regulator and power supply wiring.

Ventilation time exceeded.

The air heating element has not been cooled down sufficiently by purging. Check the combustion air supply system and the gas exhaust pipe. Test the flame detector; replace if necessary.

Fuel pump malfunction.

Check fuel pump wiring for short or open circuit. Replace if necessary.

No communication between the control panel and the heating element.

Check connecting wires and connectors.

Fan motor malfunction. The motor does not rotate.

Check the fan motor wiring for electrical conductance. Replace the motor if necessary.

Fan motor malfunction. The motor fails to shut off, keeps rotating.

Check the fan motor wiring for electrical conductance. Replace the motor if necessary.

Flame blowoff in the combustion chamber due to a voltage drop

Test the battery and wiring. (Voltage drop can be caused by long operation of the electric starter).

Circulation pump malfunction

Bleed the air from the liquid loop of the vehicle following the vehicle manufacturer's instructions.

Check circulation pump electric wiring for short circuit; check the circulation pump. Replace if necessary.

Connection to the air heater



USB adapter with set of adapters

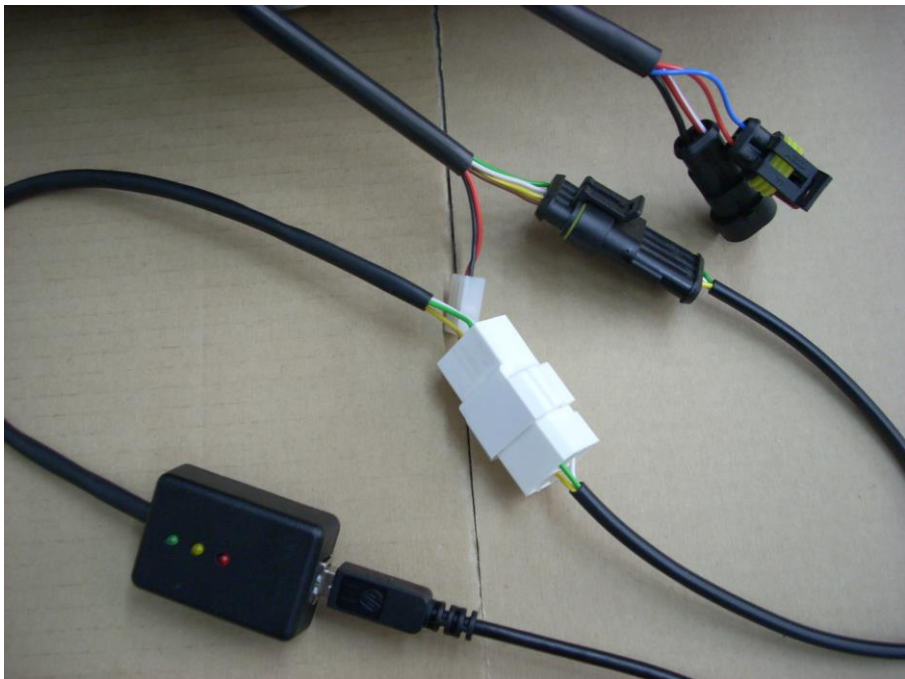

Connection to Planar 44

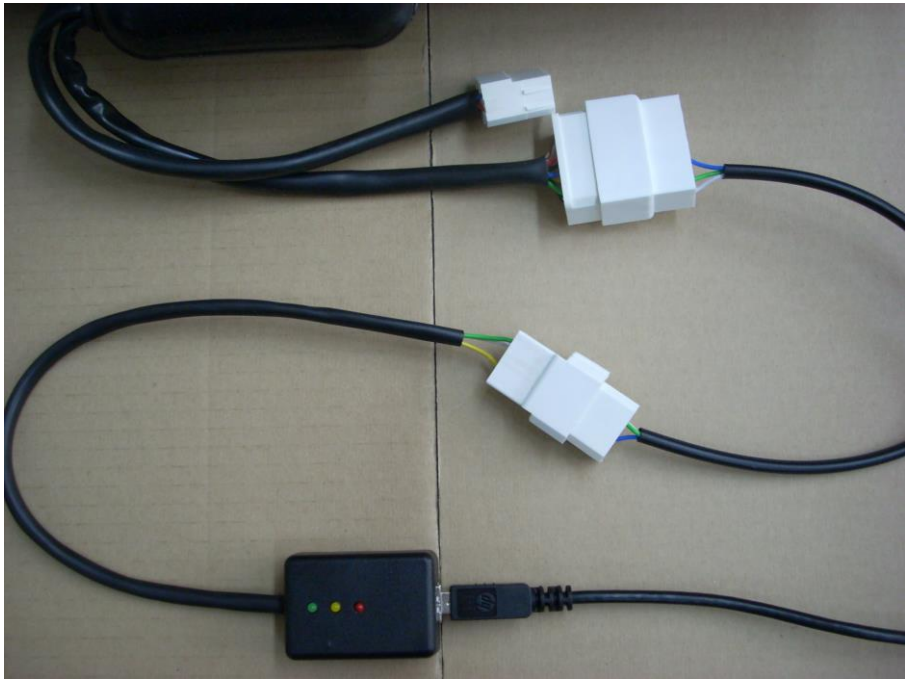

Connection to Planar 4

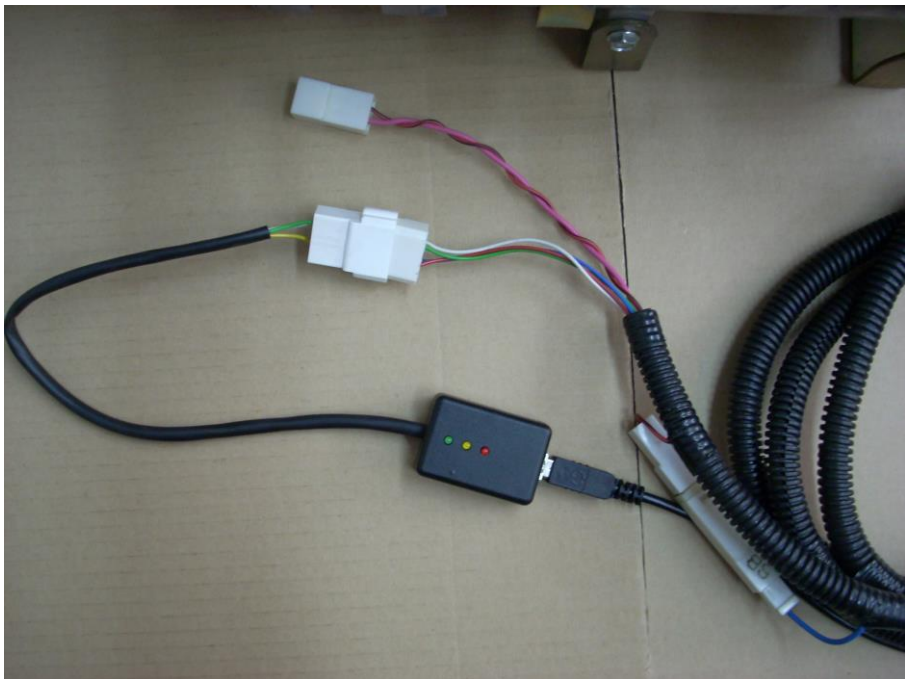

Connection to 11TC

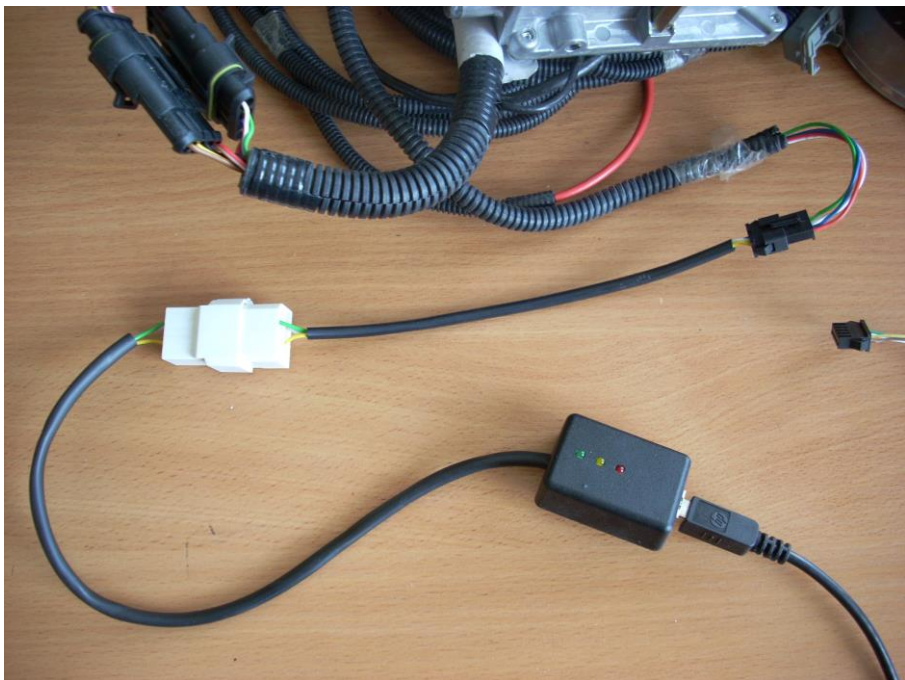
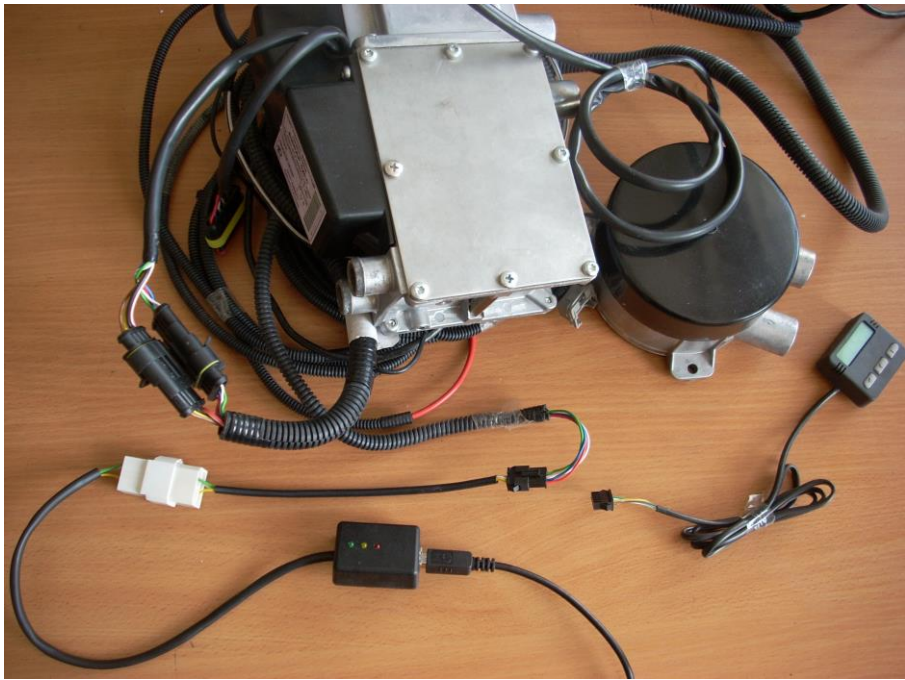

Connection to Binar 5